



# AluKlik

aluminijasti  
kotalni odri

Cenik  
veljavnost: 1. februar 2018



IMEXA d.o.o.LJUBLJANA  
Zaloška cesta 163,  
Tel.: 01 564 10 50  
mail: imexa@siol.net

## VSEBINA- KAZALO

## STRAN

1. Kotalni odri AluKlik 70/ 300-1400 ... ..	1-4
Širina 0,7; Dolžina 1,9; Delovna višina od 3,0m do 14,0m	
2. Kotalni odri AluKlik 135XXL/ 300-1400.....	5-7
Širina 1,35 ; Dolžina 1,9 ; Delovna višina od 3,0m do 14,0 m	
4. Sestavni deli AluKlik 70 + 135XXL.....	8-9

## AluKlik 70/ 250B - 400

Cenik: 01.02.2018 vse cene brez DDV

Delovna površina	0,70m x 1,9m
Max. Delovna višina	
na prostem	10,00 m
v zaprtih prostorih	14,00 m
Dovoljena obremenitev	Odri skupine 3: Max. 200 kg/m <sup>2</sup> ali 228 kg skupno

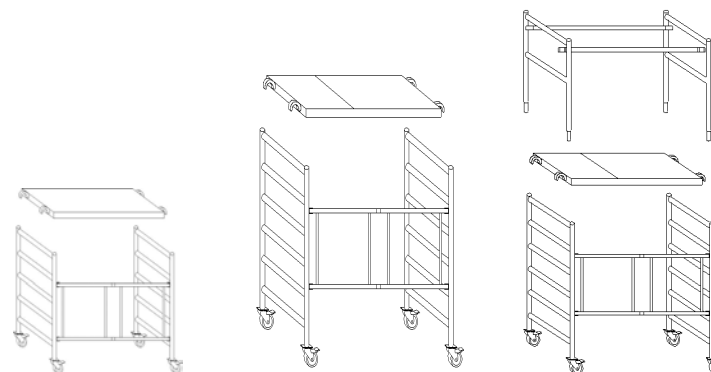

Tip odra			Aluklik 250 B	AluKlik 300	AluKlik 400
Številka artikla			K02-00-1907-0-B	K03-00-1907-0-0	K04-00-1907-0-0
Delovna višina v m			2,4	3,0	3,8
višina odra v m			1,4	1,8	2,8
Stojna višina v m			0,4	1,0	1,8
Sestavni deli	Številka artikla	Masa kg			
Zložljiva osnova	K00-FE-1607-R15	25,9	1	1	1
Zložljiva nadgradnja	K00-FE-1407-0-0	17,5	-	-	-
Prehodni podest 1,9m	H00-DB-1900-0-0	14,2	-	1	1
Podest 1,9 m	H00-BE-1900-0-0	13,8	1	-	-
Okvir ograje	K00-GR-1007-2-0	3,8	-	-	2
Vertikalni okvir 2,0 m	K00-VR-0007-7-0	8	-	-	-
Horizontalna vez 1,9m	H00-HO-1900-0-0	2,3	-	-	2
Okvir podesta	L00-BB-1907-0-0	6,9	-	-	-
Dvojna ograja	K00-DG-1900-0-0	5,6	-	-	-
Diagonalna vez 1,9m	H00-DI-1900-3-0	2,4	-	-	-
Trikotna opora 2,2m	K00-DA-2200-0-0	4,5	-	-	-
Trikotna opora 2,6m	H00-DA-2600-0-0	5,3	-	-	-
<b>Skupna masa (kg)</b>			<b>34,8</b>	<b>41,2</b>	<b>54,1</b>
<b>Skupna cena (€)</b>			<b>465,00</b>	<b>645,00</b>	<b>810,00</b>
Dodatni pribor (opcija)					
Utež	K00-BL-0010-0-K	10,0			*
Zidna opora	K00-WA-1000-0-0	0,6			-
komplet za zidno sidranje	K00-WS-0900-0-0	1,4			-

## AluKlik 70/ 500S - 700S

Cenik: 01.02.2018 vse cene brez DDV

Delovna površina	0,70m x 1,9m
Max. Delovna višina na prostem	10,00 m
v zaprtih prostorih	14,00 m
Dovoljena obremenitev	Odri skupine 3: Max. 200 kg/m <sup>2</sup> ali 228 kg skupno

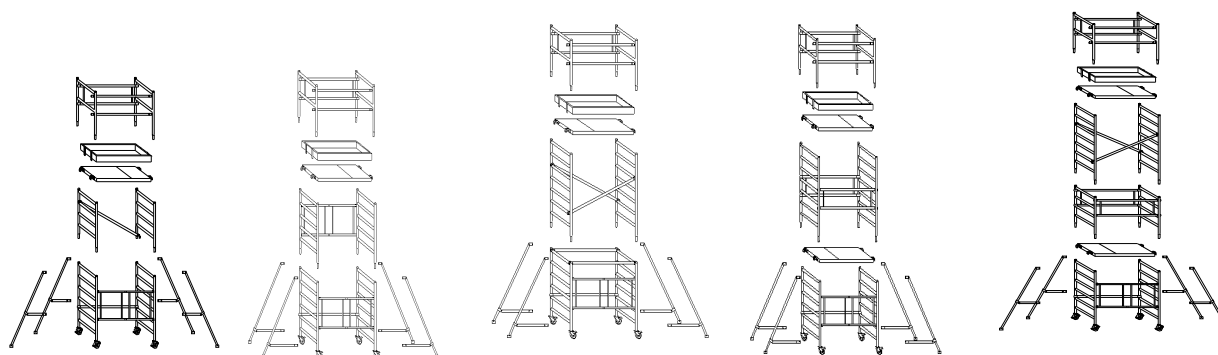

Tip odra Številka artikla	AluKlik 500 S K05-00-1907-0-S	AluKlik 500 K05-00-1907-0-0	AluKlik 600 S K06-00-1907-0-S	AluKlik 600 K06-00-1907-0-0	AluKlik 700 S K07-00-1907-0-S
Delovna višina v m	5,2	5,2	5,8	5,8	7,2
višina odra v m	4,2	4,2	4,8	4,8	6,2
Stojna višina v m	3,2	3,2	3,8	3,8	5,2
Sestavni deli					
Zložljiva osnova	1	1	1	1	1
Zložljiva nadgradnja	-	1	-	-	-
Prehodni podest 1,9m	1	1	1	2	2
Podest 1,9 m	-	-	-	-	-
Okvir ograje	2	2	2	2	2
Vertikalni okvir 2,0 m	-	-	2	2	2
Horizontalna vez 1,9m	3	3	5	3	3
Okvir podesta	1	1	1	1	1
Dvojna ograja	1	1	3	3	3
Diagonalna vez 1,9m	1	-	2	-	2
Trikotna opora 2,2m	4	4	4	4	4
Trikotna opora 2,6m	-	-	-	-	-
Skupna masa (kg)	96,0	102,0	118,6	125,2	139,0
Skupna cena (€)	1.565,00	1.670,00	1.735,00	1.960,00	2.195,00
Dodatni pribor (opcija)					

## AluKlik 70/ 700 - 960V-1400

Cenik: 01.02.2018 vse cene brez DDV

Delovna površina	0,70m x 1,9m
Max. Delovna višina na prostem	10,00 m
v zaprtih prostorih	14,00 m
Dovoljena obremenitev	Odri skupine 3: Max. 200 kg/m <sup>2</sup> ali 228 kg skupno

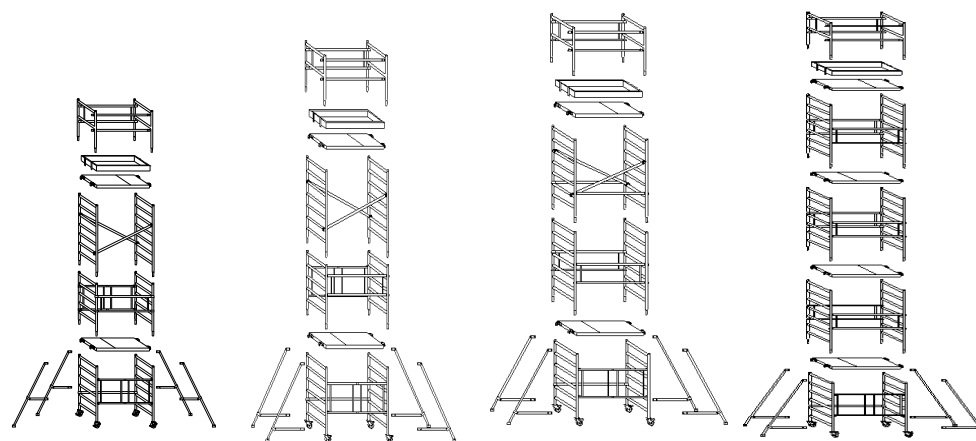

Tip odra	AluKlik 700	AluKlik 800	AluKlik 960S	AluKlik 960V
Številka artikla	K07-00-1907-0-0	K08-00-1907-0-0	K09-00-1907-0-S	K09-00-1907-0-V
Delovna višina v m	7,2	7,7	9,6	9,6
višina odra v m	6,2	6,7	8,6	8,6
Stojna višina v m	5,2	5,7	7,6	7,6
Sestavni deli				
Zložljiva osnova	1	1	1	1
Zložljiva nadgradnja	1	-	-	-
Prehodni podest 1,9m	2	2	2	4
Podest 1,9 m	-	-	-	-
Okvir ograje	2	2	2	2
Vertikalni okvir 2,0 m	2	4	6	6
Horizontalna vez 1,9m	3	5	7	3
Okvir podesta	1	1	1	1
Dvojna ograja	2	3	3	7
Diagonalna vez 1,9m	2	2	4	-
Trikotna opora 2,2m	4	4	4	4
Trikotna opora 2,6m	-	-	-	-
Skupna masa (kg)	142,6	151,7	177,3	209,3
Skupna cena (€)	2.240,00	2.330,00	2.700,00	3.050,00
Dodatni pribor (opcija)				

## AluKlik 70/ 1200 -1400

Cenik: 01.02.2018 vse cene brez DDV

Delovna površina	0,70m x 1,9m
Max. Delovna višina	
na prostem	10,00 m
v zaprtih prostorih	14,00 m
Dovoljena obremenitev	Odri skupine 3: Max. 200 kg/m <sup>2</sup> ali 228 kg skupno

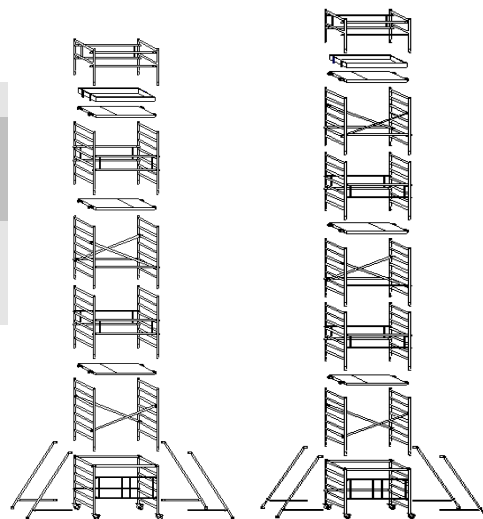

Tip odra	AluKlik 1200	AluKlik 1400
Številka artikla	K12-00-1907-0-0	K14-00-1907-0-0
Delovna višina v m	11,5	13,5
višina odra v m	10,5	12,5
Stojna višina v m	9,5	11,5
Sestavni deli		
Zložljiva osnova	1	1
Zložljiva nadgradnja	-	-
Prehodni podest 1,9m	3	3
Podest 1,9 m	-	-
Okvir ograje	2	2
Vertikalni okvir 2,0 m	8	10
Horizontalna vez 1,9m	7	9
Okvir podesta	1	1
Dvojna ograja	5	5
Diagonalna vez 1,9m	4	6
Trikotna opora 2,2m	-	-
Trikotna opora 2,6m	4	4
Skupna masa (kg)	222,1	247,7
Skupna cena (€)	3.300,00	3.670,00
Dodatni pribor (opcija)		

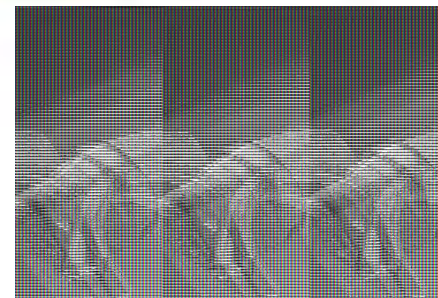

\*potrebne količine obtežitve so navedene v Navodilih za uporabo in so odvisne od vrste in načina uporabe ter postavitve



## AluKlik 135 XXL/ 300-600S

Cenik: 01.02.2018 vse cene brez DDV

Delovna površina	1,35m x 1,9m
Max. Delovna višina na prostem	10,00 m
v zaprtih prostorih	14,00 m
Dovoljena obremenitev	Odri skupine 3: Max. 200 kg/m <sup>2</sup> ali 456 kg skupno

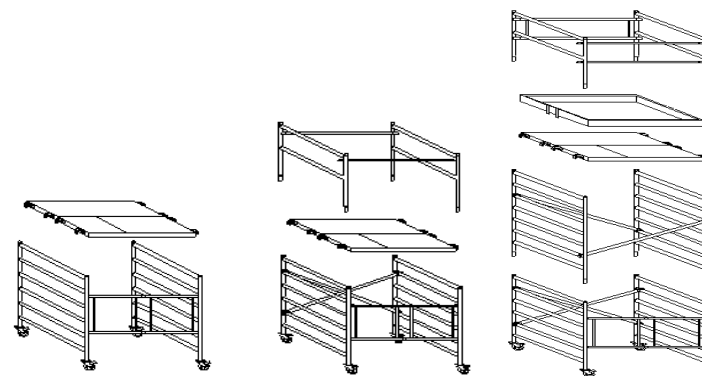

Tip odra Številka artikla			AluKlik135 - 300 K03-00-1913-0-0	AluKlik 135 - 400 K04-00-1913-0-0	AluKlik 135 - 600S K06-00-1913-0-S
	Delovna višina v m		3,0	3,8	5,8
	višina odra v m		1,8	2,8	4,8
	Stojna višina v m		1,0	1,8	3,8
Sestavni deli	Številka artikla	Masa kg			
Zložljiva osnova 135 XXL	K00-FE-1613-R20	52,0	1	1	1
Podest 1,9m	H00-BE-1900-0-0	13,8	1	1	1
Prehodni podest 1,9m	H00-DB-1900-0-0	14,2	1	1	1
Okvir ograje 135	K00-GR-1013-2-0	4,9	-	2	2
Vertikalni okvir 135 / 2m	K00-VR-0013-7-0	12,2	-	-	2
Horizontalna vez 1,9m	H00-HO-1900-0-0	2,3	-	2	2
Okvir podesta 1,35	L00-BB-1913-0-0	8,7	-	-	1
Dvojna ograja	K00-DG-1900-0-0	5,6	-	-	1
Diagonalna vez 1,9m	H00-DI-1900-3-0	2,4	-	2	4
Trikotna opora 2,2m	K00-DA-2200-0-0	4,5	-	-	-
Trikotna opora 2,6m	H00-DA-2600-0-0	5,3	-	-	-
<b>Skupna masa (kg)</b>			<b>68,5</b>	<b>87,1</b>	<b>130,6</b>
<b>Skupna cena (€)</b>			<b>915,00</b>	<b>1.210,00</b>	<b>1.800,00</b>
<b>Dodatni pribor (opcija)</b>					
Utež	K00-BL-0010-0-K	10,0	-	-	*
Zidna opora	K00-WA-1000-0-0	0,6	-	-	2
komplet za zidno sidranje	K00-WS-0900-0-0	1,4	-	-	2
Trikotna opora 2,2m	K00-DA-2200-0-0	4,5	-	-	4

## AluKlik 135 XXL / 600-1200

Cenik: 01.02.2018 vse cene brez DDV

Delovna površina	1,35m x 1,9m
Max. Delovna višina	
na prostem	10,00 m
v zaprtih prostorih	14,00 m
Dovoljena obremenitev	Odri skupine 3:
	Max. 200 kg/m <sup>2</sup>
	ali 456 kg skupno

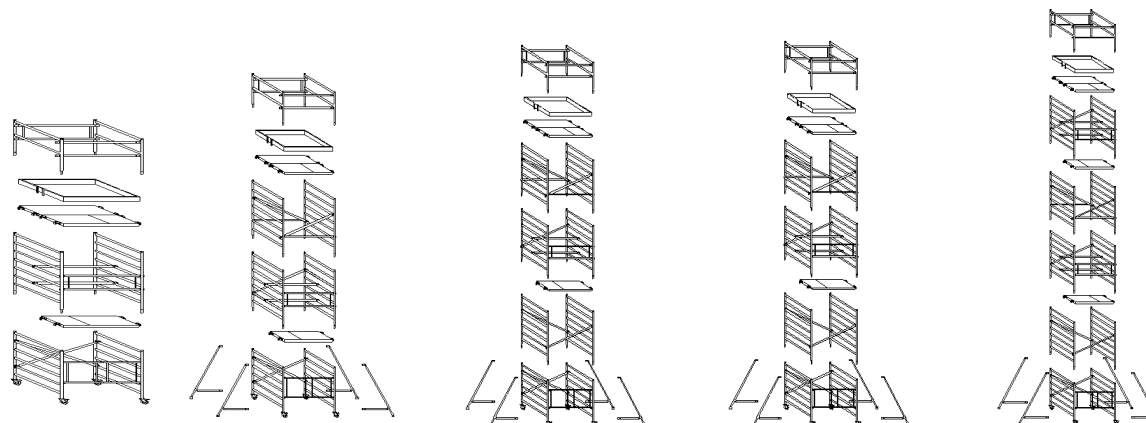

Tip odra Številka artikla	AluKlik 135 - 600 K06-00-1913-0-0	AluKlik 135 - 800 K08-00-1913-0-0	AluKlik 135 - 960S K09-00-1913-0-S	AluKlik 135-960 V K09-00-1913-0-V	AluKlik 135-1200 K12-00-1913-0-0
Delovna višina v m	5,8	7,7	9,6	9,6	11,6
višina odra v m	4,8	6,7	8,6	8,6	10,6
Stojna višina v m	3,8	5,7	7,6	7,6	9,6
Sestavni deli					
Zložljiva osnova 135 XXL	1	1	1	1	1
Podest 1,9m	1	1	1	1	1
Prehodni podest 1,9m	2	2	2	4	3
Okvir ograje 135	2	2	2	2	2
Vertikalni okvir 135 / 2m	2	4	6	6	8
Horizontalna vez 1,9m	4	6	6	8	8
Okvir podesta 1,35	1	1	1	1	1
Dvojna ograja	2	2	2	4	3
Diagonalna vez 1,9m	2	5	7	7	8
Trikotna opora 2,2m	-	4	4	4	-
Trikotna opora 2,6m	-	-	-	-	4
<b>Skupna masa (kg)</b>	<b>150,2</b>	<b>180,1</b>	<b>233,6</b>	<b>274,0</b>	<b>288,0</b>
<b>Skupna cena (€)</b>	<b>2.080,00</b>	<b>2.940,00</b>	<b>3.340,00</b>	<b>3.895,00</b>	<b>4.050,00</b>
Dodatni pribor (opcija)					
Utež	*	*	*	*	*
Zidna opora	2	2	2	2	2
komplet za zidno sidranje	2	2	2	2	2
Trikotna opora 2,2m	4	s.o.	s.o.	s.o.	-



## AluKlik 135 XXL 1400

Cenik: 01.02.2018 vse cene brez DDV

Delovna površina	1,35m x 1,9m
Max. Delovna višina	
na prostem	10,00 m
v zaprtih prostorih	14,00 m
Dovoljena obremenitev	Odri skupine 3:
	Max. 200 kg/m <sup>2</sup> ali 456 kg skupno

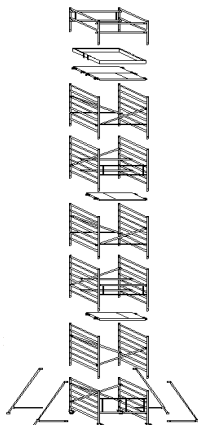

Tip odra	AluKlik 135-1400
Številka artikla	K14-00-1913-0-0
Delovna višina v m	13,5
višina odra v m	12,5
Stojna višina v m	11,5
<b>Sestavni deli</b>	
Zložljiva osnova 135 XXL	1
Podest 1,9m	1
Prehodni podest 1,9m	3
Okvir ograje 135	2
Vertikalni okvir 135 / 2m	10
Horizontalna vez 1,9m	10
Okvir podesta 1,35	1
Dvojna ograja	3
Diagonalna vez 1,9m	10
Trikotna opora 2,2m	-
Trikotna opora 2,6m	4
<b>Skupna masa (kg)</b>	<b>321,8</b>
<b>Skupna cena (€)</b>	<b>4.525,00</b>
<b>Dodatni pribor (opcija)</b>	
Utež	*
Zidna opora	2
komplet za zidno sidranje	2
Trikotna opora 2,2m	-

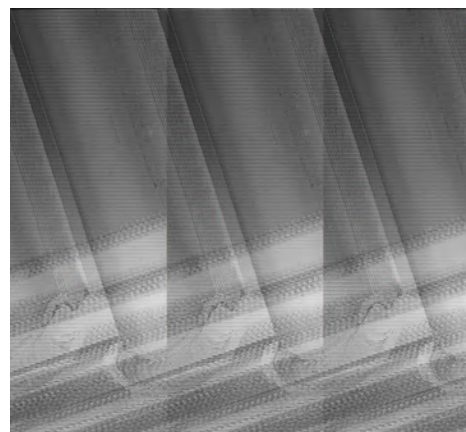









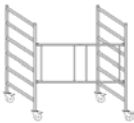
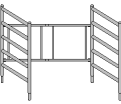

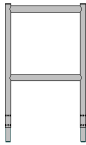





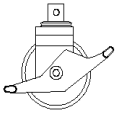

\*potrebne količine obtežitve so navedene  
V navodilih za uporabo in so odvisne od  
vrste in načina uporabe ter postavitve

## AluKlik Sestavni deli

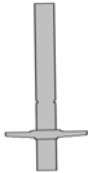
vse cene brez DDV

Cenik 01.02.2018

Opis	slika	Višina / Širina m	Masa kg	Naročn.-štev.	Cene* EUR
Zložljiva osnova 70		1,80 / 0,68	25,9	K00-FE-1607-R15	548,00
Zložljiva osnova 135 XXL		1,80 / 1,29	40,5	K00-FE-1613-R20	735,00
Zložljiva nadgradnja (samo za 70)		1,50 / 0,68	17,5	K00-FE-1407-0-0	408,00
Vertikalni okvir 2,0 m 70		1,93 / 0,68	8,0	K00-VR-0007-7-0	145,00
Vertikalni okv. 2,0 m 135 XXL		1,93 / 1,29	12,2	K00-VR-0013-7-0	200,00
		1,93 / 0,68	4,3	K00-VR-0007-4-0	
		1,93 / 1,29	6,7	K00-VR-0013-4-0	
Okvir ograje 70		1,02 / 0,68	3,8	K00-GR-1007-2-0	67,00
Okvir ograje 135 XXL		1,02 / 1,29	4,9	K00-GR-1013-2-0	86,00
Dvojna ograja		1,90 / 0,57	5,6	K00-DG-1900-0-0	115,00
Horizontalna vez 1,9 m		Dolžina 1,90	2,3	H00-HO-1900-0-0	45,00
Diagonalna vez 1,9 m		Dolžina 1,90	2,4	H00-DI-1900-3-0	46,00
Trikotna opora 2,2 m		Dolžina 2,20	4,5	K00-DA-2200-0-0	96,00
Trikotna opora 2,6 m		Dolžina 2,60	5,3	H00-DA-2600-0-0	115,00
Prehodni podest 1,9 m		1,90 / 0,60	14,2	H00-DB-1900-0-0	199,00
Podest neprehodni 1,9m		1,90 / 0,60	13,8	H00-BE-1900-0-0	195,00
Okvir podesta		1,90 / 0,70	6,9	L00-BB-1907-0-0	97,00
		1,90 / 1,35	8,7	L00-BB-1913-0-0	190,00

Opis	slika	Višina / Širina m	Masa kg	Naročn.-štev.	Cene* EUR
Kolo premera 125			1,2	K00-ET-ROL125-P	15,00
Kolo premera 150			2,4	K00-ET-ROL150-P	35,00
Kolo z dvojnimi vzvodom 200			3,9	L00-ET-ROL200-N	55,00
Navojno vreteno z matico za kolesa premera 150 in 200 nastavljivo		Dolžina 0,50	2,4	K00-ET-SPIN0500	47,00
Utež 10kg		0,40x0,40 x0,05	10,0	K00-BL-0010-0-K	18,00
Zidna opora in nosilec za uteži		Dolžina 0,28	0,6	K00-WA-1000-0-0	35,00
Komplet za zidno sidranje Nosilec, standardna spojka, zidni vijak, vložek in stenska pokrovna kapica		Dolžina 0,9	1,4	K00-WS-0900-0-0	55,00
Podnožje nastavljivo območje 19 cm		Višina 0,60	3,0	S00-FP-0615-0-0	
Podnožje nastavljivo območje 54cm		Višina 0,90	4,0	S00-FP-0915-0-0	
Aluminijasto navojno vreteno		Dolžina 0,58	1,00	L00-ET-SPIN0580	

\*Vse cene brez vklj. DDV

**IMEXA d.o.o**  
**Zaloška cesta 163**  
**1000 LJUBLJANA**  
**tel. (01) 546 10 50**  
**mail: [imexa@siol.net](mailto:imexa@siol.net)**